

CALIFORNIA PATH PROGRAM
INSTITUTE OF TRANSPORTATION STUDIES
UNIVERSITY OF CALIFORNIA, BERKELEY

Paramics API Development Document for Actuated Signal, Signal Coordination and Ramp Control

Henry X. Liu, Lianyu Chu, Will Recker
University of California, Irvine

**California PATH Working Paper
UCB-ITS-PWP-2001-11**

This work was performed as part of the California PATH Program of the University of California, in cooperation with the State of California Business, Transportation, and Housing Agency, Department of Transportation; and the United States Department Transportation, Federal Highway Administration.

The contents of this report reflect the views of the authors who are responsible for the facts and the accuracy of the data presented herein. The contents do not necessarily reflect the official views or policies of the State of California. This report does not constitute a standard, specification, or regulation.

Report for MOU 3013

February 2001

ISSN 1055-1417

Paramics API Development Document
for Actuated Signal, Signal Coordination and Ramp Control

by

Henry X. Liu

Lianyu Chu

Will Recker

California PATH ATMIS Center
University of California at Irvine

December 2000

Table of Contents

1. Introduction	1
2. Full-actuated Signal Control	3
2.1 Intersection Layout with Detectors	3
2.2 Configuration of Detectors for Actuated Signal	4
2.3 Data Requirements for Actuated Signal API	5
2.3.1 The “ <i>signal_control</i> ” file	6
2.3.2 The “ <i>priorities</i> ” file	7
2.4 Control Logic and Pseudo Code	8
2.5 Actuated Signal Control Interface	9
2.6 Limitations of Current API	9
2.7 Future Development	10
3. Actuated Signal Coordination	11
3.1 Control Logic and Pseudo Codes	11
3.2 Data Requirements	12
4. Actuated Ramp Control	14
4.1 Ramp Layout with Detector	14
4.2 Data Requirements for Actuated Ramp API	14
4.2.1 The “ <i>ramp_control</i> ” file	15
4.2.2. The “ <i>priorities</i> ” file	16
4.2.3 <i>Constant Parameters</i>	16
4.3 Control Logic and Pseudo Code	17
4.4 Ramp Control Interface	18
4.5 Future Development	19
Reference	20
APPENDIX 1 Working Steps For Collecting Junction / Ramp Information	21
Part 1 Junction And Offramp	21
Documents required	21
Working steps	21
Part 2 Ramp	23
APPENDIX 2 Preparation of the “ <i>priorities</i> ” file	25
1. Notes for making “ <i>priorities</i> ” file	25
2. Examples	26
2.1 + <i>shape junction #1</i>	26
2.2 + <i>shape junction #2</i>	28
2.3 <i>T-shape junction</i>	30
2.4 <i>Off-ramp</i>	32
2.5 <i>On-ramp</i>	33
APPENDIX 3 Paramics API Development Qs & As	34

1. Introduction

Paramics is a suite of high performance software tools used to model the movement and behavior of individual vehicles on urban and highway road networks. The Paramics Project Suite consists of Modeller, Processor, Analyzer, and Programmer. Paramics Programmer is a framework that allows the user to customize many features of underlying simulation model. Access is provided through a Functional Interface or Application Programming Interface (API).

The capability to access and modify the underlying simulation model through API is essential for research. Such an API should have a dual role, first to allow researchers to override the simulators default models, such as car following, lane changing, route choices for instance, and second, to allow them to interface complementary modules to the simulator. Complementary modules could be any ITS application, such as signal optimization, adaptive ramp metering, incident management and so on. In this way, new research ideas could be easily tested using simulator before the implementation in the real world.

Three developed APIs are documented in this report; namely, full-actuated signal control, actuated signal coordination, and actuated ramp metering control. Section 2, 3, and 4 will have detailed descriptions for each of them. In each section, the control logic, data structure and control interface, data input requirements, and some implementation considerations are included.

2. Full-actuated Signal Control

Generally, there are three types of traffic signal controllers: pretimed controller, semi-actuated controller, and full-actuated controller. Since pretimed controller can be modeled directly in Paramics Modeller, and semi-actuated controller API could be obtained from some minor modification through full-actuated signal controller API, only full-actuated signal API is developed and described here.

2.1 Intersection Layout with Detectors

Figure 1 illustrates the typical intersection layout with standard NEMA eight-phase numbering system. The illustration shows similar phasing for both intersecting arteries. This layout is self-explained clearly and could be modeled easily in Paramics.

The emphasis here is the configuration of detectors. We modeled 16 detectors in a typical intersection. For each approach, there are three detectors close to the stop line for through and left turn vehicle presence detection, and one advance detector located at about 150-300 feet to the stop line, used to detect vehicles for the extension of the through movement phase. Although each detector covers all lanes for one approach, each lane has its own detector in Paramics.

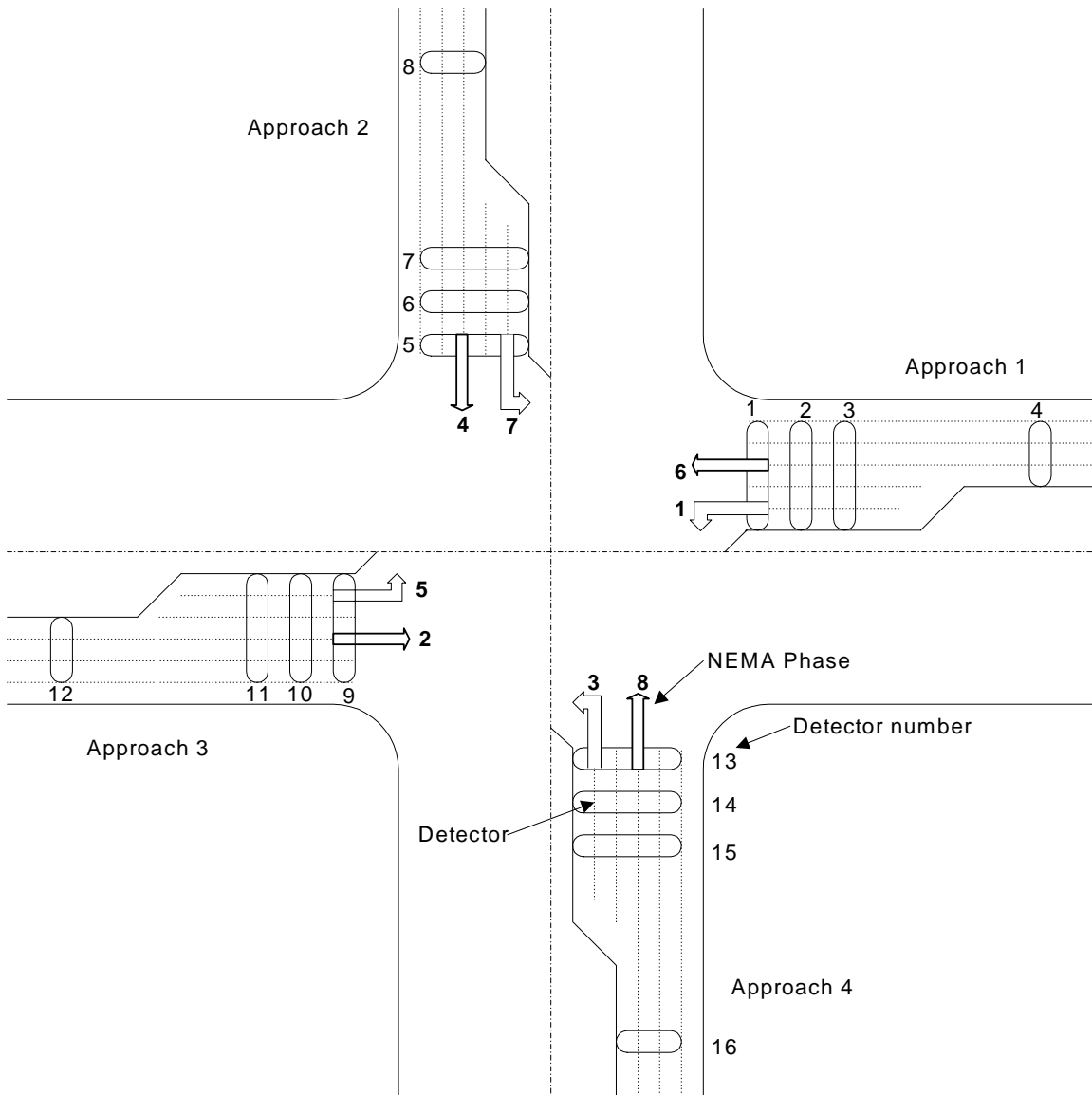

Figure 1. Typical Intersection Layout with NEMA phases

2.2 Configuration of Detectors for Actuated Signal

Generally, there are three groups of detectors in each approach for the typical intersection in the real world. They are: (1) double loop detectors, located in the through lanes and very close to the stop bar, for the presence detection of through vehicles; and (2) advance loop detector, located at almost 150—300 feet from the stop bar, used to detect vehicles for the extension of the through movement phase; and (3) one long loop detector in the left turn lane, with the length of about 50-70 feet, for the presence detection of left turn vehicles. For some intersections, there maybe no advance detector for all approaches or the minor approaches.

To better simulate the functionality of detectors, ideally, detectors should be modeled in Paramics according to the real-world configuration. However, some problems exist as follow: (1) Paramics can't simulate the long-loop vehicle presence detector. The reason is that Paramics uses the rising and falling edge of loop detector to decide if there is a vehicle entering the area of the loop, i.e., when the front end of one vehicle passes the rising edge, vehicle is present on the loop; and when the back end of the vehicle passes the falling edge, the loop is empty without any vehicle. However, if the loop is long enough to accommodate more than one vehicle, and there are two or more vehicles on the loop at the same time, when the first vehicle leaves the loop, the loop becomes empty according to Paramics even though other vehicles may still stay on the loop. This is certainly not the case in the real world. (2) Since traffic simulation is a discrete process, Paramics calculates the location of vehicles at every time step. The loop count variable does not work properly when the vehicle speed is a little bit high, say 40mph. Visually, we can see that vehicles passed the loop detector, but the loop count remains the same. This is a systematic problem of Paramics loop module. (3) Each detector covers all lanes. We can't put one long loop detector on the left turn lane, and short detectors on through lanes.

Since the long loop can't be simulated by Paramics, we have to use some small ones to replace it. Detectors' locations for the left turn lane is designed in Figure 2. Three 2m or 6.6 ft long loops are used to mimic one 50ft long loop detector.

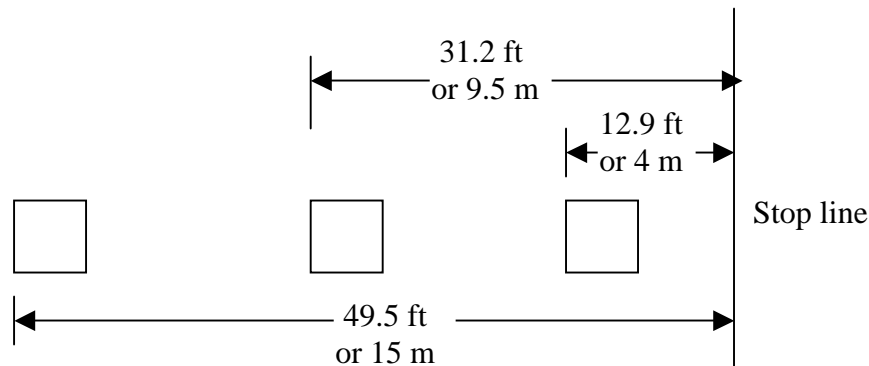

Figure 2. Detectors' location for the left turn lane

The detector used for left turn can also be used for through movement since the detector in Paramics covers all lanes. Here we use these two detectors close to stop line to detect the vehicle presence. An advance detector will be put in the upstream location depending on the realistic design.

2.3 Data Requirements for Actuated Signal API

Two files need to be prepared for the use of signal control API. One is the "priorities" file, provided by Paramics, to be used to identify the hierarchy of movements for all phases. The "priorities" file could be modified and generated through the graphical display of priority panel in the Edit Junction window. One can also type the proper text

into the “priorities” file manually. The other is the so-called “signal_control” file, which contains all the information in the signal timing chart and intersection layout data.

2.3.1 The “signal_control” file

The “signal_control” file includes all the related information in the signal time chart and intersection layout data. Figure 1 may need to be referenced when the “signal_control” file is made. This file should be put to the same directory as that of the road network files. The format of “signal_control” file is:

total number of actuated signals is: XX

Node	Node_ID	Node_Name						
movements								
ini_green								
extension								
max_green								
Recall								
Lanes								
rightturn								
detector1								
detector2								
detector3								
detector4								

Where “**node**” is the node ID in the road network, following by the description of the intersection;

“**movements**” describes the designated phase diagram, NEMA phase numbering system is used here;

“**ini_green**” is the initial green time for 8 phases, corresponding to “Initial” in the Signal Timing Chart,

“**extension**” is the extension time for 8 phases, corresponding to “Extension” in the Signal Timing Chart;

“**max_green**” is the maximal green time for 8 phases, corresponding to “Max Green” in the Signal Timing Chart;

“**recall**” is the recall phases, corresponding to “Min Recall” in the Signal Timing Chart;

“**lanes**” is the number of lanes corresponding to each movement. If a turning movement shares a lane with a through movement, consider this to be 0.5 of a lane for this turning movement. The same lane should be counted as 1.0 lane for the through movement. If right turn and left turn share a lane, the left one is the one counted as 1.0 (for off-ramp case);

“**rightturn**” is the number of right turn lanes from Approach 1 to Approach 4;

“**detector1**” to “**detector4**” are names of detectors. The first four columns of the row of “detector1” should contain the detectors for approach 1. You’ll find approach 2-4 counter-clockwise around the junction.

An example of signal_control file is as following:

total number of actuated signals is: 1

```
node 6 ALTON & ICD
movements      1      2      3      4      5      6      7      8
ini_green      5      5      5      5      5      5      5      5
extension      3      5      3      5      3      5      3      5
max_green     24     32     24     32     24     32     24     32
recall         2      6
lanes          2      3      2      3      2      3      2      3
rightturn     1      1      1      1
detector1     aisw   ai2w  ai3w  aiuw
detector2     aiss  ai2s  ai3s  aius
detector3     aise  ai2e  ai3e  aiue
detector4     aism  ai2n  ai3n  aiun
```

More detailed information about making the “signal_control” file can be found in APPENDIX 1.

2.3.2 The “priorities” file

The “priorities” file, provided by Paramics, to be used to identify the hierarchy of movements for all phases. A hierarchy of priorities exists in the order of MAJOR, MEDIUM, MINOR, and BARRED. MAJOR priority movements are free flow and not restricted by other streams of traffic. A MEDIUM priority yields to MAJOR streams of traffic but has priority over MINOR traffic movements. MINOR priority yields to both MAJOR and MEDIUM traffic flow while BARRED indicates the turn is banned to all vehicle movements.

The following is an example, which defines the phase 1 priority of intersection “528z”. Those words after “//” are explanations.

```
actions 528z // node name
phase offset 0.00 sec
phase 1
  0.00 // default stored green time
  max 100.00 // maximal green time
red phase 0.00 // red phase time
fill // no yellow time
all barred except // the following defines priority of movements
from 7510 to 7511 minor
from 7511 to 7612 minor
from 7511 to 7510 major
from 7612 to 7614 minor
from 7614 to 7612 major
from 7614 to 7510 minor
```

More detailed information about making the “priorities” file can be found in APPENDIX 2.

2.4 Control Logic and Pseudo Code

The dual-ring, concurrent concept is illustrated briefly in Figure 3. Note that eight phases are shown, each of which accommodates one of the through or left turning movements. A “barrier” separates the north-south phases from the east-west phases. Any phase in the top group (Ring 1) may be displayed with any phase in the bottom group (Ring 2) on the same side of the barriers without introducing any traffic conflicts. For simplicity, the right turns are omitted and assumed to proceed with the through movements.

In full-actuated signal control, all phases at an intersection are actuated, then the length of each phase, and consequently the cycle length, will vary with each cycle. Some phases may be skipped if there is no vehicle actuation. To simulate the real controller better, the order and sequence of phases can also be altered.

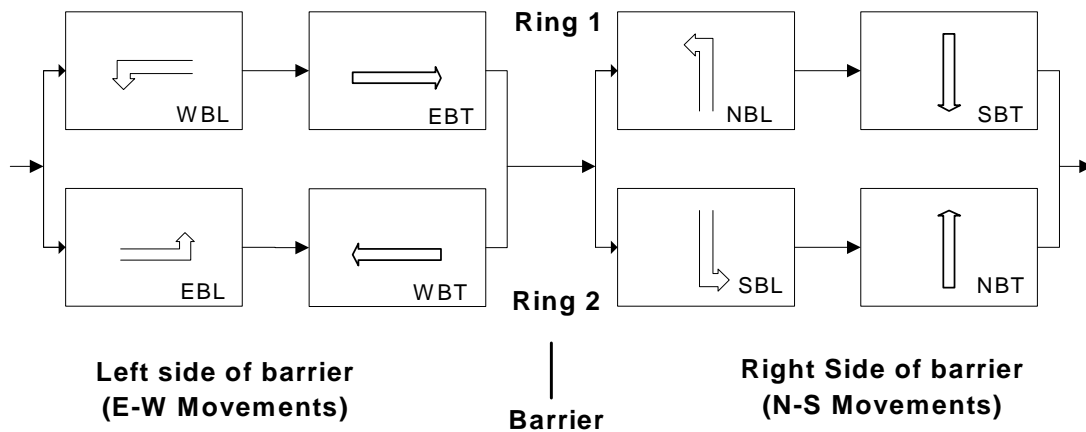

Figure 3. Dual-ring concurrent phasing scheme with assigned movements

In order to implement the above dual-ring concept, the pseudo code for the main control logic is given in the following:

1. Actuated Signal API set up using `api_setup()`, includes signal data input, memory allocation, and initial signal phase set up.
2. At every time step, `net_action` is called:

```

      For controller intersection = 1 : n {
        a. Inquiry the current signal information using signal_inquiry().
        b. If ( left green time == 0 ) {
            Amber and red time are counted.
            If ( amber and red time are reached )
              Set the next signal phase parameters through signal_action().
          }
        else {
          vehicle presence detection ( pp_presence_dection() ).
          excute the current signal plan ( pp_excute_plan() ) {
            If ( left green time < extension &&
              vehicle presence for extension &&
      
```

```

        expired green < ( maximal green – extension ) ) {
            green time increased by (extension – left green).
        }
    If ( left green time <= time step )
        Find the next phase by vehicle presence
    }
}
}
}

```

2.5 Actuated Signal Control Interface

Once the signal control API is loaded in Paramics, the existing signal control will be overridden. To access and set the signal parameters, control interface is provided with two functions: **pp_set_signal_parameters (Signal *sig)** and **pp_get_signal_parameters (Char *nodeName)**. The description of the **Signal** type is given below:

```

type Signal
{
    //the intersection name and location
    char *node;
    char *controllerLocation;

    // the signal paramters
    int movements[8];
    float maximumGreen[8];
    float minimumGreen[8];
    float extension[8];
    float storedRed[8];

    // current phase information
    int currentPhase;
    int expiredTime;
}

```

2.6 Limitations of Current API

1) During our development on full-actuated signal control API, we found that Paramics didn't provide an API function for user to control the amber time (yellow light). Although yellow time can be set in the configuration file, it is universal for all the intersections and all the time. It is not convenient in the actuated signal case since some phases may be skipped (the amber time has to be skipped at the same time). In order to simulate the real world better, our developed APIs have to have a handle on the control of the amber time associated with each phase. Currently, there is no `action_type` in the `signal_action()` related to the control of yellow time. We strongly suggest that Paramics can provide this function, and this will improve the simulation quality on actuated signal control greatly.

2) In Paramics, phase and movement are different. For the current actuated signal API implementation, each phase usually includes two major movements, and some minor movements. For instance, phase 1 may include dual left turn movements, and some right

turn minor movements. Paramics run through phase 1 to phase 8, some phases may be skipped depends on the vehicle presence. However, each movement has its own initial green and extension in the signal-timing sheet. Only one set of parameters could be used in each phase. Although the reasonable set of parameters is calculate and used during the simulation, and the simulation performance won't be hurt by doing this, the actual signal controller can't be fully simulated in this API. Ideally, we want each phase includes only one major movement, and two phases can be executed at the same time. But Paramics can't do this at the current time.

2.7 Future Development

Real-time Signal Control Optimization for Isolated Intersection Using Wide-Area Detection Technologies

Effective signal control has long been as one of the most direct methods for relieving urban traffic congestion. The primary goal of this research is to design a real-time signal control optimization algorithm to minimize the total delay experienced by traffic and improve the system performance and safety at insolated signalized intersections via wide-area vehicle detection technology. Compared with traditional inductive loop detector, wide-area detector is capable of detecting vehicles over the entire length of the so called "dilemma zone" on each approach to the intersection. Machine vision, as one of the most promising viable wide-area detector, is rapidly approaching to the mature stage to be used in the field.

Using the provided state parameters of an intersection by wide-area detectors, the objective function of the optimization algorithm is to minimize the cumulative delay of all vehicles passing through an intersection, with the weighted time delay for different vehicle type, subject only to the efficiency, safety and fairness of the traffic in different approaches. The solution to the objective function is provided through genetic algorithm, and the rolling horizon concept will be used in the calculation of the optimal signal plan. The generated signal plan will include optimal phase sequencing and phase parameter settings. Any arbitrary phase sequencing and phase split with variable length clearance interval are permitted in the optimal signal plan.

3. Actuated Signal Coordination

Coordination is a mode of signal operation designed to allow platoons of traffic to form and "progress" through several signals with minimum stops and delay. Where signals are closely spaced and traffic volumes are high, coordination of signals is necessary to avoid excessive delay and stops.

The actuated signal coordination API inherits most parts of full-actuated signal API, with additional force-off logic to maintain the background cycle length, and form green band for a particular phase (sync phase).

3.1 Control Logic and Pseudo Codes

To provide synchronization and maintain the background cycle length, all coordinated intersection have the same system clock reference point, which is usually the start point of signal coordination plan. For the fixed-time signal coordination plan, there is an offset, which is the difference between two green initiations of the sync phase for two adjacent intersections. However, for the traffic-actuated signal coordination, the sync phase of every coordinated intersection has fixed series of yield points, and the difference between yield points is the background cycle length. These yield points are also local clock reference points to other non-sync phases. The sync phase has minimal bandwidth, i.e. the sync phase has to start at the time of minimal bandwidth earlier than yield point. To do so, all other phases have to be cut at certain points, which are so-called force-off points. These force-off points are usually referenced to the local clock reference point. Figure 4 is the phase diagram of coordinated intersection.

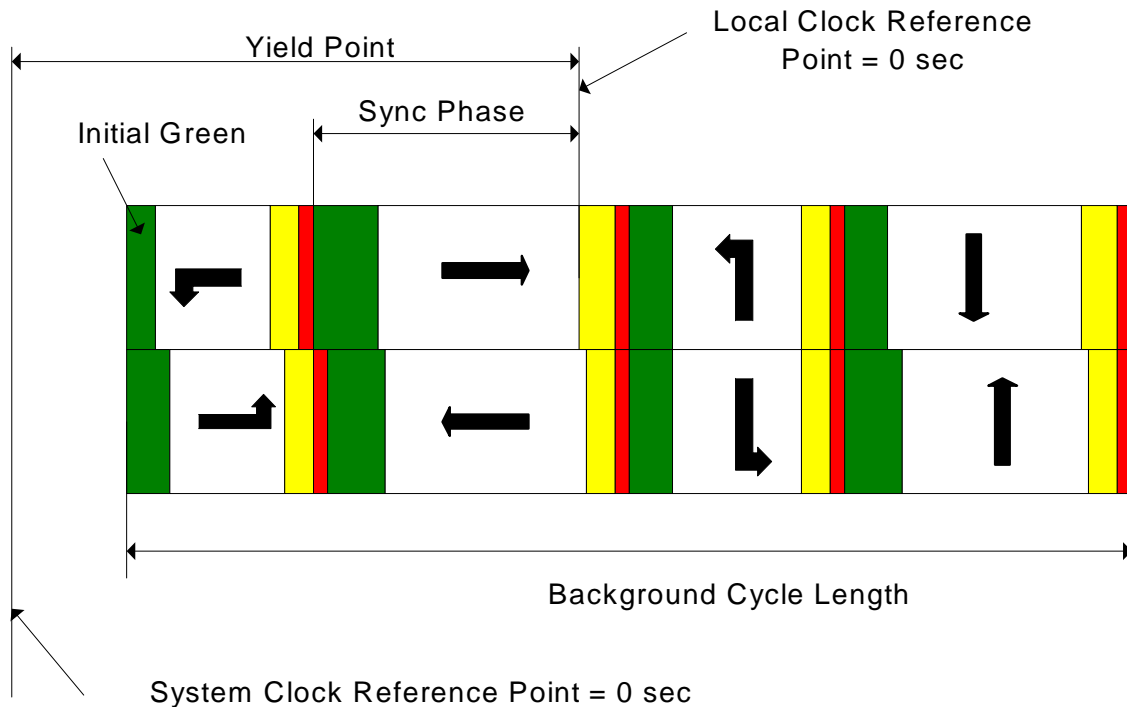

Figure 4. Actuated Signal Coordination

In order to implement the above concept, the pseudo code for the main control logic is given in the following:

1. Actuated Signal API set up using `api_setup()`, includes signal data input, memory allocation, and initial signal phase set up.
2. At every time step, `net_action` is called:

```

      For controller intersection = 1 : n {
        a. Inquiry the current signal information using signal_inquiry( ).
        b. Vehicle presence detection (pp_presence_dection( )).
        c. If (left green time > 0) {
            Check if this phase should be forced off (pp_force_off( )).
            If (force-off)
                Find the next phase by vehicle presence.
            else {
                excute the current signal plan (pp_excute_plan( )) {
                    If ( left green time < extension &&
                        vehicle presence for extension &&
                        expired green < ( maximal green – extension ) ) {
                        green time increased by (extension – left green).
                    }
                    If ( left green time <= time step ) {
                        Find the next phase by vehicle presence.
                    }
                }
            }
        }
      }
      else {
        Amber and red time are counted.
        If ( amber and red time are reached )
            Set the next signal phase parameters through signal_action( ).
      }
    
```

3.2 Data Requirements

As the actuated signal API, two files need to be prepared for the use of signal coordination API. One is the “priorities” file, provided by Paramics, to be used to identify the hierarchy of movements for all phases. The other is the so-called “signal_coordination_control” file, which contains all the signal timing information, intersection layout information, and coordination information.

The following is an example of the part of “signal_coordination_control” file for one intersection.

```

total number of actuated signals is: 4

node 6 ALTON & ICD

```

movements	1	2	3	4	5	6	7	8
ini_green	5	5	5	5	5	5	5	5
extension	3	5	3	5	3	5	3	5
max_green	24	60	24	32	24	32	24	32
recall	2	6						
lanes	2	3	2	3	2	3	2	3
rightturn	1	1	1	1				
detector1	aisw	ai2w	ai3w	aiuw				
detector2	aiss	ai2s	ai3s	aius				
detector3	aise	ai2e	ai3e	aiue				
detector4	aisn	ai2n	ai3n	aiun				
sync_phase	2	6						
cycle_length	60							
force_off	36	60	18	27	36	60	18	27
yield_point	5							
system_clock	0							

The data for signal coordination has been attached after the intersection layout data for each intersection. Besides to the yield point of the sync phase, all other phases have force-off points, referenced to the local clock reference point. Notice that the maximal green time of primary sync phase has to be the cycle length, since the green time of sync phase may occupy the entire cycle if there is no conflict traffic.

4. Actuated Ramp Control

There have been a number of strategies to release vehicles into the mainline freeway traffic, each with different demands on sophistication of control and detectorization. The actuated ramp API here is an implementation of time-based ramp control algorithm in Paramics. This API will not calculate the ramp rate/cycle but require them as data inputs. Other more complex actuated ramp APIs could be developed based on this one by integrating ramp rate/cycle calculation with respect to real traffic data inputs.

4.1 Ramp Layout with Detector

A typical ramp layout with detector is given in Figure 5. Vehicles are released from ramp to the mainline traffic at a fixed ramp metering rate during the certain time period. Every vehicle has to stop before the stop lane, waiting for the green signal. The detector for sensing the presence of a vehicle allows the signal to rest in red, avoiding potential confusion to a driver approaching the signal, due to the short greens. The ramp-control signal, mounted close to driver level, generally provides two indications, green and red only.

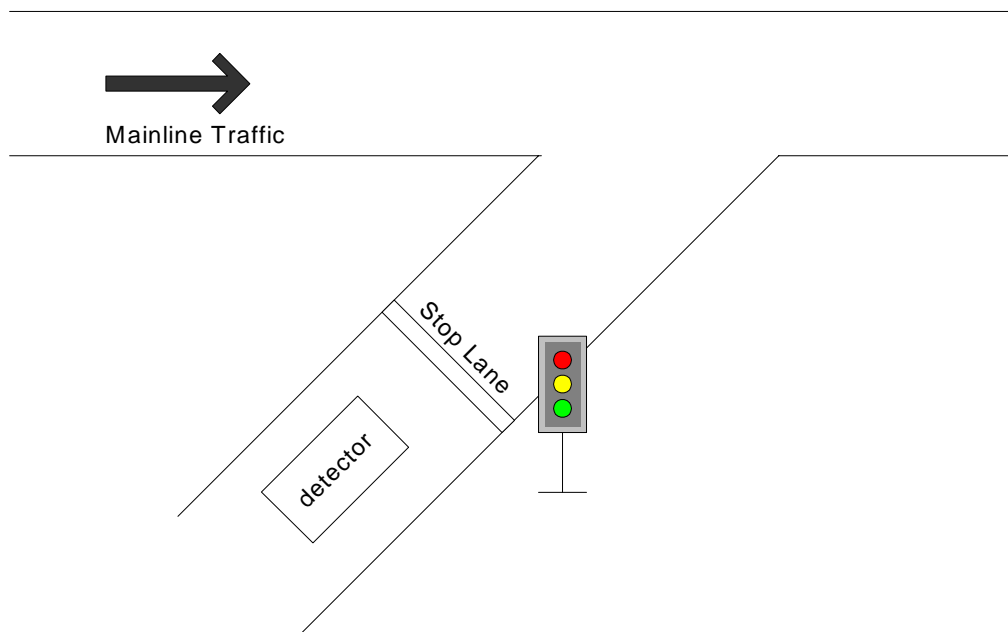

Figure 5. A typical ramp metering layout

4.2 Data Requirements for Actuated Ramp API

In order to run Paramics with the actuated ramp API, two files need to be prepared:

- (1) "ramp_control" file is the input of actuated ramp API including the ramp control information, such as ramp name, control type, cycle, effective time, etc.
- (2) "priorities" file is a system file of Paramics, provided with the action and phase definition of a ramp signal.

4.2.1 The “ramp_control” file

“ramp_control” file includes the ramp control information, such as ramp name, control type, cycle, effective time, etc., and these information are the inputs of actuated ramp API.

“ramp_control” should be put to the same directory as that of the road network files. The format of “ramp_control” file is:

```
total number of actuated ramps is:  XX

ramp      XX
name      XX
detector   XX
lanes     XX
plans     XX
from XX:XX to XX:XX with cycle XX controltype XX
```

Where “*ramp*” is the global node number in the road network,
“*name*” is the description of the ramp location,
“*detector*” is the detector name for the ramp,
“*lanes*” is the number of on-ramp lanes,
“*plans*” is the number of ramp control plans, and
“*controltype*” represents the number of vehicles that can drive through the ramp signal within one green. The possible value is OFF, SINGLE, DOUBLE, TRIPLE, ON. If the “*lanes*” is 2, the control type can only be SINGLE vehicle pass for the reason of safety. If controltype is OFF, ramp is always OFF (ramp is closed); if controltype is ON, ramp is always ON.

An example of ramp_control file is as following:

```
total number of actuated ramps is:  1

ramp 7567
name ICD & NB405E
detector icdnb405
lanes 2
plans 5
from 0: 0 to 6: 0 with cycle 0 controltype ON
from 6: 0 to 9: 0 with cycle 6 controltype SINGLE
from 9: 0 to 15: 0 with cycle 0 controltype ON
from 15: 0 to 19: 0 with cycle 6 controltype SINGLE
from 19: 0 to 24: 0 with cycle 0 controltype ON
```

More detailed information about making ramp_control can be found in APPENDIX 1.

4.2.2. The “priorities” file

“priorities” file, a system file of Paramics, provided with the action and phase definition of a ramp signal. There are only two phases for each ramp signal. Phase 1 is the red signal to stop vehicles from entering the freeway directly. Phase 2 is the green signal to release the waiting vehicle into the freeway. An example of the “priorities” is as following:

```
actions 3480
phase offset 0.00 sec
phase 1
    0.00
    max 36.00
red phase 0.00
fill
all barred except
phase 2
    0.00
    max 36.00
red phase 0.00
fill
all barred except
from 3907 to 3452 major
```

Where “fill” means no yellow will be shown. The initial lengths for both phases are set to 0 according to the above example, and these lengths will be reset when the actuated ramp API is running.

More materials regarding the “priorities” file could be found Paramics user manual. You can also find some useful hints from the Appendix 2.

4.2.3 Constant Parameters

Some constant parameters are included in “actuated_ramp_c.h” file may influence the performance of simulation. These parameters includes:

- (1) SINGLE_VEH: The green time for one vehicle to pass the ramp signal per cycle
- (2) DOUBLE_VEH: The green time for two vehicles to pass the ramp signal per cycle
- (3) TRIPLE_VEH: The green time for three vehicles to pass the ramp signal per cycle
- (4) DEFAULT_RED_AMBER: Red/amber signal time
- (5) MAX_PLAN: The maximal number of the time-of-day ramp control plans
- (6) RAMP_CYCLE: If no vehicle arrives within a RAMP_CYCLE, a green time will be given eventually in case that a vehicle before the stop line may not be detected by the detector because of the system problem of Paramics.

The default configuration of those control parameters is as following:

```
#define SINGLE_VEH 2.5
#define DOUBLE_VEH 4.5
#define TRIPLE_VEH 6
#define MAX_PLAN 10
#define DEFAULT_RED_AMBER 0
#define RAMP_CYCLE 20
```

4.3 Control Logic and Pseudo Code

In the API control logic, the time-based ramp metering rate is fixed within the specific time window, but can be changed according to the different time period. The metering rate is determined by the expected mainline volume and by a decision on how much volume can be allowed in from the particular ramp. The green indication is generally 2 to 3 seconds, sufficient to pass one vehicle.

As an illustration, suppose the ramp signal cycle length is 10 seconds from 4pm to 6pm. This is one vehicle every 10 seconds, so that a setting of a 2 sec of green followed by 8 sec of red could be used. The metering rate in this case is 360 vph.

The implemented actuated ramp API in Paramics has several limitations. (1) Although the carpool lane has no ramp signal, Paramics can't simulate the condition that one lane has signal, the other has not. (2) For unclear reasons, sometimes the presence detector of Paramics does not work correctly, i.e. sometimes a vehicle can't be detected though it is present on the detector. This case is very rare, however, this may cause severe problems in the simulation since all the following vehicles are blocked, and the signal may remain red all the time. To solve this problem, a green signal is given as long as the time of red signal is over RAMP_CYCLE, which is described in the above chapter.

The control logic is given in the following pseudo codes:

- (1) Initialization using api_setup()
 - Read in all ramp information.
 - Allocate memories for all pointers to be used.
 - Store all necessary ramp information to global data structures.
 - Check the existence of ramp nodes and correspondent detectors.
 - Initialize the ramp signals based on the initial simulation time.

- (2) Main program using net_action()
 - Get simulation time.
 - For controlled ramp = 1 : n {
 - Check the current running phase.
 - Get green left time of the current running phase
 - Find the correct ramp control plan according to the simulation time
 - If (ramp cycle length changed due to entering another time period) {

```

        notify the operator
        Recalculate the green times for the 2 phases
    }
    If (controtype is always ON)
        set next green time for “always ON”
    Else if (controtype is always OFF)
        set next green time for “always OFF”
    Else{
        If ( the running phase is 2 && green left time <= time step )
            Set the next green time for phase 1
        Else if (the running phase is 1){
            If (no vehicle presence) {
                If(the running time is less than RAMP_CYCLE)
                    continue to increment green time for phase 1
                Else (the running time is equal to RAMP_CYCLE)
                    set the next green time for phase 2
            }
            else
                Set the next green time for phase 2
        }
    }
}

```

4.4 Ramp Control Interface

There are two interface functions to get and set ramp metering rate for a specific ramp. The prototypes are as follows:

```

void pp_set_ramp_parameters( RAMP *ramp, Bool parameter )
RAMP *pp_get_ramp_parameters( char *ramptime )

```

Where parameter = TRUE means to set a new ramp cycle that overrides the default one while parameter = FALSE means to restore default ramp cycle according to ramp_control file. The ramptime is the name of ramp as shown in ramp_control file. RAMP is a structure of ramp data, whose definition is:

```

typedef struct Ramp_data RAMP;
struct Ramp_data{
    char *node;
    char *name;
    int type;
    int cycle;
};

```

4.5 Future Development

The ramp metering algorithms developed to date can be classified into one of four general categories: (1) fixed-time or time-of-day, (2) traffic-responsive, (3) hybrids combining attributes of traffic-responsive and time-of-day algorithms, and (4) integrated freeway/surface-street metering algorithm.

The integrated freeway/surface-street metering algorithm, addressing real-time control of ramp meters of a freeway segment, with consideration of the traffic volumes entering and leaving the freeway from/to arterials, and the regulation of these volumes via real-time setting of ramp metering rates, is the research direction of ramp metering algorithms. This kind of ramp metering control algorithm should contain the following modules: (1) traffic anomaly detection; (2) area-wide coordination; (3) ramp rate regulation. These modules need to be developed separately with the output of ramp rates/cycles for all ramps by using more control parameters, including queue length, upstream traffic condition and downstream traffic condition, etc.

The current ramp API could be extended by the development and test of other advanced ramp control algorithms. These algorithms can be implemented through the call of the interface functions provided by this actuated ramp API.

Reference:

1. **McShane, W. R., Roess, R. P., and Prassas, E. S., “Traffic Engineering”, Second Edition, Prentice Hall, 1998.**
2. **NCHRP Web Document, “Capacity Analysis of Traffic-Actuated Intersections: Final Report”, 1998.**
<http://www.nap.edu/openbook/nch010/html/79.html>.
3. **“Model 170 Traffic Signal Control Operational Manual”, Caltrans, 1985.**
4. **“Multisonics Model 820A-VMS Vehicle Management System User Guide”, Intersection Development Corporation, 1994.**
5. **“Modeller V3.0 User Guide”, Quadstone Ltd., February 2000.**
6. **“Modeller V3.0 Reference Manual”, Quadstone Ltd., February 2000.**
7. **“Processor V3.0 Reference Manual”, Quadstone Ltd., February 2000.**
8. **“Analyzer V3.0 User Guide”, Quadstone Ltd., February 2000.**
9. **“Analyzer V3.0 Reference Manual”, Quadstone Ltd., February 2000.**
10. **“Programmer V3.0 User Guide”, Quadstone Ltd., February 2000.**
11. **“Programmer V3.0 Reference Manual”, Quadstone Ltd., February 2000.**

APPENDIX 1 Working Steps For Collecting Junction / Ramp Information

Part 1 Junction And Offramp

Documents required:

- (1) Worksheet for intersection
- (2) Signal Timing Chart obtained from the proper government agency (i.e. Caltrans)
- (3) Layout of the intersection
- (4) “detector” file of Paramics

Working steps:

Please see the attached format of “signal_control” file.

- (1) Write down the name of the intersection, i.e. Alton & Barranca, and the signal ID that is shown in the first page of signal timing chart.
- (2) Find the first NEMA movement, generally a left turn, in the Signal Timing Chart. Write down the turn arrow and the movement number 1 (all NEMA movements / phases will be decided based on the 1st one). **If the first movement is none**, please do a regular analysis based on the movement sequence on the first page of the Signal Timing Chart and define what the 1st movement should be if it exists. Then we regard that movement as the 1st movement though it doesn't exist. Then write down the turn arrow and the movement number 2 for NEMA movement 2 at the opposite approach.. The approach that the 1st NEMA movement locates is defined as approach 1 here. The counter-clockwise approaches around the junction are defined as approach 2, 3, 4.
- (3) Write down the two street names, the detector IDs, the junction node name and the four neighbouring nodes on four approaches.
- (4) Fill out the 3-5 rows (ini_green, extension, max_green) of the table in the worksheet. The ini_green corresponds to the “Initial”(green time) and the max_green corresponds to the “Max Green” in the Signal Timing Chart.
- (5) Find out the recall movement from the Signal Timing Chart. Enter the two recall movement numbers to the first two columns of “recall” row. If there is no recall movement, just write “0”. If only one recall, the second column of recall is “0”.
- (6) Compare the 8 movements, defined for the intersection just now, with the standard NEMA phases / movements. In general, the values written in the “movement” row should be 1,2, ...,8. But the second half phases should require more attention. It's possible to have a sequence change (3,4<->7,8). Write down the corresponding movement number according to the standard NEMA movements. Of course the first movement must be 1 since that's the basis.
- (7) From layout, find out how many lanes for one movement. Fill them in the “lanes” row. If a turning movement shares a lane with a through movement, consider this to be 0.5 of a lane for this turning movement. The same lane should be counted as 1.0 lane for the through movement. If right turn and left turn share a lane, the left one is the one counted as 1.0 (offramp).
- (8) From layout, find out how many right turn lanes for an approach. Write down these numbers in the rightturn row. The 1st approach corresponds to the approach direction as NEMA movement 1 found in step 2. The other approaches can be defined counter-clockwise.
- (9) The “detector1’ to “detector4” rows will fill in the name of detectors that can be found from “detector” file of Paramics. The first four columns of the row of “detector1’ should

contain the detectors for approach 1. You'll find approach 2-4 counter-clockwise around the junction. The detectors on the approach 2-4 should fill in rows of "detector2" to "detector4". See figure 2 for the detailed position of the detectors.

- (10) For the missing movements, some intersection will not have all movements, such as T-junctions. Write down "9" at each row except the "recall", which includes two kinds of information, and "movement", which represents if it's the same as the NEMA standard. The right turn lanes information should be analyzed. For locations where there are no detectors, enter "N/A" into these spaces.

Notes:

- (1) In order to distinguish the Paramics phase and the NEMA phase, we just use movement instead of phase in NEMA
- (2) Since only one yellow time can be used for the whole one simulation, the default yellow time is defined as 3 seconds. The red clearance is set to 1 seconds.
- (3) The standard NEMA phases / movement is shown in Figure 1.
- (4) The numbering system for the detectors is shown in Figure 2. Normally, detectors 4,8,12 and 16 are the advanced detectors.
- (5) Please write down OFFRAMP if the junction is an off_ramp.

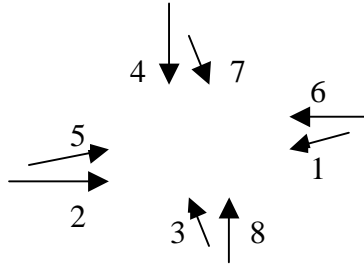

Figure 1 NEMA standard movement / phase

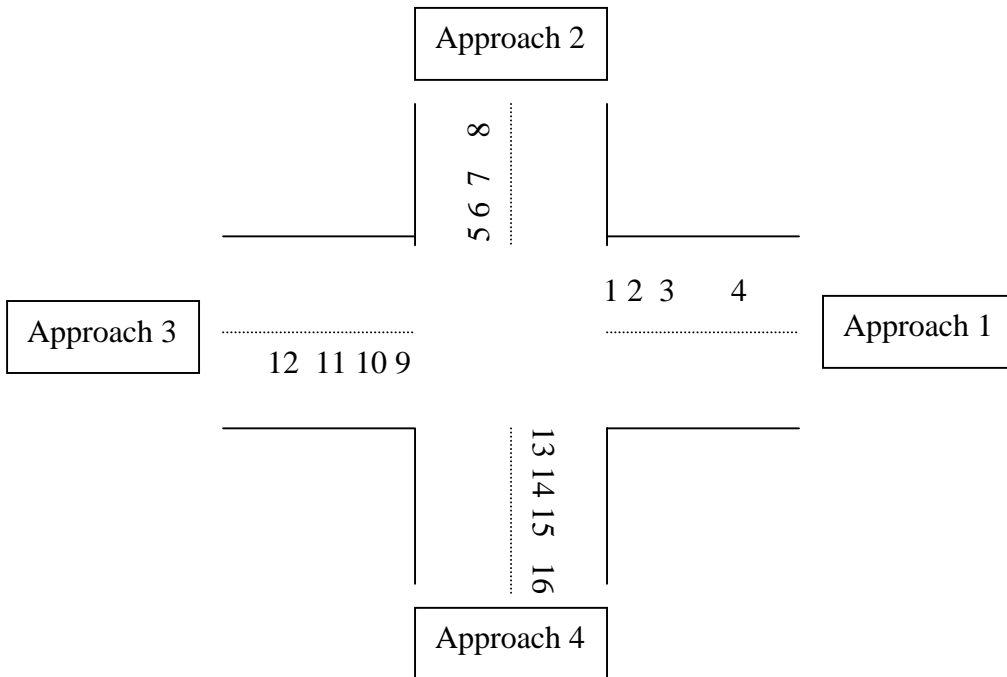

Figure 2 Detector numbering based on NEMA phases

TABLE 1 The format of “signal_control” file:

total number of actuated signals is: XX

node								
movements								
ini_green								
extension								
max_green								
recall								
lanes								
rightturn								
detector1								
detector2								
detector3								
detector4								

Part 2 Ramp

“ramp_control” file that includes the ramp control information, such as ramp name, control type, cycle, effective time, etc., are the inputs of actuated ramp API.

“ramp_control” should be put to the same directory as that of the road network files. The format of “ramp_control” file is:

total number of actuated ramps is: XX

```

ramp XX
name XX
detector XX
lanes XX
plans XX
from XX:XX to XX:XX with cycle XX controltype XX
    
```

Where “total number of actuated ramps is: XX” is only shown in the first row of “ramp_control” file. The meaning of other rows in “ramp_control” is as follows:

- “ramp” is the global node number in the road network
- “name” is the name of the ramp used for linking Paramics and Cartesius
- “detector” is the correspondent name of the detector for a ramp
- “lanes” is the number of on-ramp lanes
- “plans” is the number of ramp control plans

“controltype” represents the number of vehicles that can drive through the ramp signal within one green. The possible value is OFF, SINGLE, DOUBLE, TRIPLE, ON. If the “lanes” is 2, the control type can only be SINGLE vehicle pass for the reason of safety. If controltype is OFF, ramp is always OFF (ramp is closed); if controltype is ON, ramp is always ON.

An example of ramp_control file is as following:

total number of actuated ramps is: 10

ramp 7567
name ICD & NB405E
detector icdnb405
lanes 2
plans 5
from 0: 0 to 6: 0 with cycle 0 controltype ON
from 6: 0 to 9: 0 with cycle 6 controltype SINGLE
from 9: 0 to 15: 0 with cycle 0 controltype ON
from 15: 0 to 19: 0 with cycle 6 controltype SINGLE
from 19: 0 to 24: 0 with cycle 0 controltype ON

APPENDIX 2 Preparation of the “priorities” file

Since the maximum number of phases Paramics can support is 15, we can use 8 Paramics phases to simulate various combinations of an actuated signal. The “priorities” file has all the definition of actions and phases for each junction.

Generally, there are four cases for a junction or ramp:

1. + shape junction #1
NEMA standard phases, right-turn is allowed as minor.
2. + shape junction #2
Not NEMA standards phases, phases might be combined.
3. T shape junction
NEMA standard phases, right-turn (if the right turn exists) is allowed as minor.
4. Off-ramp
There are only two active phases. One is for through movements of vehicles on the surface street, and the other one is for the left turn movements of vehicles from the off-ramp.
5. On-ramp
There are only two phases. Phase 1 is the red signal to stop vehicles from entering the freeway directly. Phase 2 is the green signal to release the waiting vehicle into the freeway.

It’s possible for some intersections to have more complex situation and thus we should do a regular analysis (to get the category) for each intersection in order to make the “priorities” file. If there are some special features about the intersection, we should understand it in detail first.

1. Notes for making “priorities” file

1) The first two lines in “priorities” is always like the following:

```
actions 8  
phase offset 0 sec
```

The string after “actions” is the name of node in Paramics.

2) For any junctions except on-ramp, 8 phases will be written in “priorities” file. Some phases only have the following lines:

```
phase 6  
0.00  
max 100  
red phase 0.00  
all barred except
```

This means there is no action of the phase. In general, there is another line in “priorities”: fill that is often adding to the line between “red phase” and “all barred except”. If there is a “fill”, that means no amber light being shown.

3) The max green is set to 100 sec for the reason that we can set any length of max green time when the actuated signal is running.

4) If you want to add a new action to a phase, you can do that. The result is that that new movement is allowed in that phase. Thus if there are only two phases, one for each direction with the permitted left turn, permitted right turn and through movement, we can regard it as phase 4 or 8 with some minor movements. At that time the dominant movement is the through movement.

2. Examples

2.1 + shape junction #1

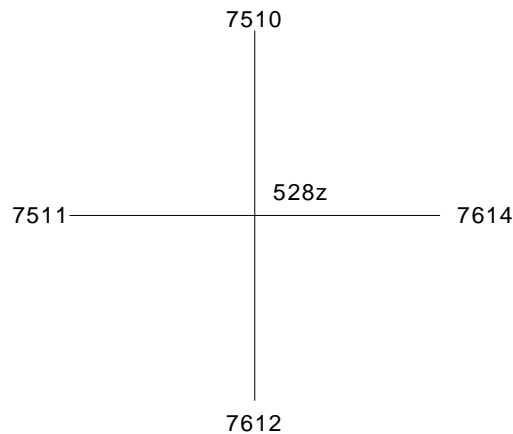

Figure 1. Intersection Layout

For the intersection as Figure1, the definition of phases and actions in “priorities” file would be:

```

actions 528z
phase offset 0.00 sec
phase 1
    0.00
    max 100.00
red phase 0.00
fill
all barred except
from 7510 to 7511 minor
from 7511 to 7612 minor
from 7511 to 7510 major
from 7612 to 7614 minor
from 7614 to 7612 major
from 7614 to 7510 minor
phase 2
    0.00
    max 100.00
red phase 0.00
fill
all barred except

```

from 7510 to 7511 minor
from 7511 to 7612 minor
from 7511 to 7614 major
from 7511 to 7510 major
from 7612 to 7614 minor
from 7614 to 7510 minor
phase 3

0.00

max 100.00

red phase 0.00

fill

all barred except

from 7510 to 7511 minor
from 7511 to 7612 minor
from 7612 to 7614 minor
from 7614 to 7511 major
from 7614 to 7612 major
from 7614 to 7510 minor

phase 4

0.00

max 100.00

red phase 0.00

fill

all barred except

from 7510 to 7511 minor
from 7511 to 7612 minor
from 7511 to 7614 major
from 7612 to 7614 minor
from 7614 to 7511 major
from 7614 to 7510 minor

phase 5

0.00

max 100.00

red phase 0.00

fill

all barred except

from 7510 to 7511 minor
from 7510 to 7614 major
from 7511 to 7612 minor
from 7612 to 7511 major
from 7612 to 7614 minor
from 7614 to 7510 minor

phase 6

0.00

max 100.00

red phase 0.00

```

fill
all barred except
from 7510 to 7511 minor
from 7510 to 7612 major
from 7510 to 7614 major
from 7511 to 7612 minor
from 7612 to 7614 minor
from 7614 to 7510 minor
phase 7
    0.00
    max 100.00
red phase 0.00
fill
all barred except
from 7510 to 7511 minor
from 7511 to 7612 minor
from 7612 to 7511 major
from 7612 to 7614 minor
from 7612 to 7510 major
from 7614 to 7510 minor
phase 8
    0.00
    max 100.00
red phase 0.00
fill
all barred except
from 7510 to 7511 minor
from 7510 to 7612 major
from 7511 to 7612 minor
from 7612 to 7614 minor
from 7612 to 7510 major
from 7614 to 7510 minor

```

2.2 + *shape junction #2*

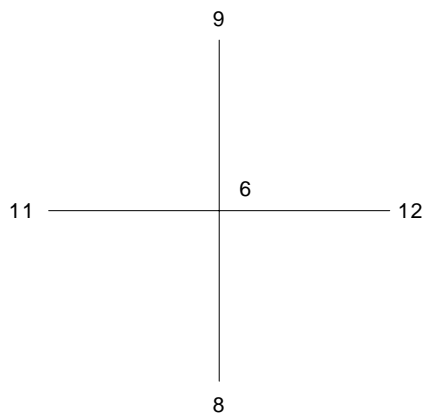

Figure 2. Intersection Layout

In this example, there are only 2 phases, each one corresponds bi-directions along one intersected street, where three movements, left, through, right are allowed. For the intersection as Figure 2, the definition of phases and actions in “priorities” file would be:

```
actions 6
phase offset 0 sec
phase 1
    0.00
    max 100
    red phase 0.00
    all barred except
phase 2
    0.00
    max 100
    red phase 0.00
    all barred except
phase 3
    0.00
    max 100
    red phase 0.00
    all barred except
phase 4
    0.00
    max 100
    red phase 0.00
    all barred except
from 12 to 11 major
from 11 to 12 major
from 12 to 8 medium
from 11 to 9 medium
from 12 to 9 minor
from 9 to 11 minor
from 11 to 8 minor
from 8 to 12 minor
phase 5
    0.00
    max 100
    red phase 0.00
    all barred except
phase 6
    0.00
    max 100
    red phase 0.00
    all barred except
phase 7
```

```

0.00
max 100
red phase 0.00
all barred except
phase 8
0.00
max 100
red phase 0.00
all barred except
from 9 to 8 major
from 8 to 9 major
from 9 to 12 medium
from 8 to 11 medium
from 12 to 9 minor
from 9 to 11 minor
from 11 to 8 minor
from 8 to 12 minor

```

2.3 T-shape junction

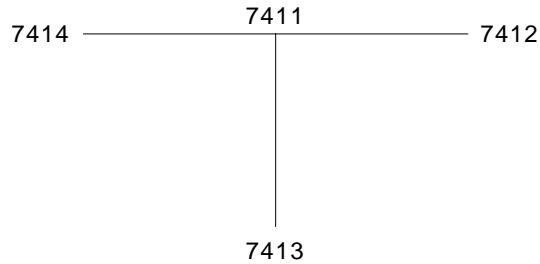

Figure 3. Intersection Layout

For the intersection as Figure 3, the definition of phases and actions in “priorities” file would be:

```

actions 7411
phase offset 0 sec
phase 1
0.00
max 100
red phase 0.00
all barred except
phase 2
0.00
max 100
red phase 0.00
all barred except
from 7412 to 7414 major
from 7412 to 7413 major
from 7414 to 7413 minor

```

from 7413 to 7412 minor
phase 3

0.00
max 100
red phase 0.00

all barred except

phase 4

0.00
max 100
red phase 0.00

all barred except

from 7414 to 7412 major
from 7412 to 7414 major
from 7414 to 7413 minor
from 7413 to 7412 minor

phase 5

0.00
max 100
red phase 0.00

all barred except

phase 6

0.00
max 100
red phase 0.00

all barred except

from 7413 to 7414 major
from 7414 to 7413 minor
from 7413 to 7412 major

phase 7

0.00
max 100
red phase 0.00

all barred except

phase 8

0.00
max 100
red phase 0.00

all barred except

2.4 Off-ramp

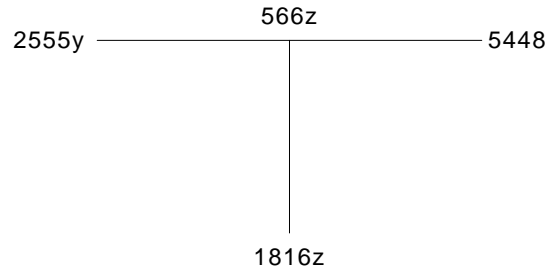

Figure 4. Intersection Layout

For the intersection as Figure 4, the definition of phases and actions in “priorities” file would be:

```
actions 566z
phase offset 0 sec
phase 1
    0.00
    max 100
    red phase 0.00
    all barred except
phase 2
    0.00
    max 100
    red phase 0.00
    all barred except
phase 3
    0.00
    max 100
    red phase 0.00
    all barred except
phase 4
    0.00
    max 100
    red phase 0.00
    all barred except
from 2555y to 5448 major
from 5448 to 2555y major
phase 5
    0.00
    max 100
    red phase 0.00
    all barred except
phase 6
    0.00
    max 100
```

```

red phase 0.00
all barred except
phase 7
0.00
max 100
red phase 0.00
all barred except
phase 8
0.00
max 100
red phase 0.00
all barred except
from 1816z to 2555y major
from 1816z to 5448 major

```

Notice that right turn is prohibited according to the “phase 4”. That will protect the mainline traffic.

2.5 On-ramp

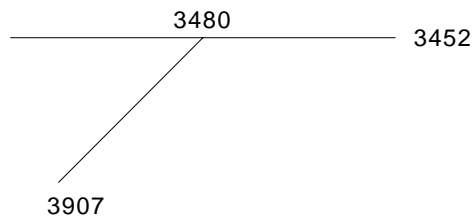

Figure 5. Ramp Layout

For the ramp as Figure 5, the definition of phases and actions in “priorities” file would be:

```

actions 3480
phase offset 0.00 sec
phase 1
9.50
max 36.00
red phase 0.00
fill
all barred except
phase 2
2.50
max 36.00
red phase 0.00
fill
all barred except
from 3907 to 3452 major

```

APPENDIX 3: Paramics API Development Qs & As

The following questions we asked during the development of Paramics APIs were answered by Paramics technical support Mr. Scott Aitken and Mr. Ewan Speirs.

Q1. I use the plan/phase/priorities to implement the actuated signal. There is a long stopline loop for the left turn vehicles with the length of 50-75 feet. The facts are as follows:

I want to use occupied[] to decide if there are vehicles waiting on the loop, I found: if one vehicle, that can be called #1, enters the loop (before that no vehicle), then occupied[]=TRUE. At that time it's red signal and thus the vehicle has to stop. Then another 2 vehicles, #2 and #3, enters the loop (occupied[]=TRUE within the red time of the phase). Since the loop is long enough, all three are within the loop. When the green is coming, #1 runs out and occupied[] turns to FALSE though there are still two vehicles over the loop. Then, if no vehicle enter the loop, #2 runs out, occupied[] can't change to TRUE. if a vehicle enters the loop and then #2 runs out, occupied[] turns to TRUE. Based on the above facts, the loop in Paramics works according to the two edges, upstream edge and downstream edge. That means the loop can not be present type loop. Please tell me some solutions to it, use two or more short loops, or some basic methods to cope with the left turn phase of dual ring actuated signal. Or, if it is a problem of Paramics, you can add some codes to make the loop intelligent.

Q2. I found there is a delay of signal control in Paramics. If I want to stop the current green time if there is no left turn vehicle. I'll do the following:

```
if (!occupied[1]){  
    report time;  
    report green1;  
    green1=0;  
    report green1;  
}
```

I have thought to stop the green1 and then continue to the next phase. The result of it is that the green1 will continue to increase to the maximum green. Then I found that the reports are:

```
time =6.5  
green1=7  
.....  
green1=7.5
```

So, since the condition !occupied[1] is satisfied then, a loop produces until the maximum green. Of course, I have solved the problem to avoid to use if (!occupied[1]). Based on the above, I think there is a second >delay. Is my idea right?

Q3. UC Irvine has the plugin code of controller 170. The output of it are four files: plan, phase, priorities, detectors. Is that the correct way to do the API programming for actuated signal? We are doing it without changing those files. What's your idea about our plan?

Q4. We are using API programming to replace the plan/phase method. But I found there is no API function that can output occupied[] values. I'd like to know how the occupied[] function is implemented.

[Q5.](#) I would like to know if I can run Paramics under Linux, a personal Unix?

[Q6.](#) I reset my computer's clock(forward to Oct.19) because of other needs. After that, I found that the Windows version Paramics entered the demonstration with the error: Clock Reset Detected. Then I realized that the license of Paramics will be expired on Sep. 30.

[Q7.](#) I have another question about what you told me last time. The following is based on three 6.6 feet loops instead of one 50 feet loop.You told me that Paramics uses occupancy to get occupied(). Before, we use count to get occupied(). Thus I tried to change and use incomplete occupancy, but it doesn't work well. After my observation, I found that the loop nearest the junction works OK, but the second and third loops(even the loop in the middle of the link) can't reflect incomplete occupancy. They just kept the occupancy value of last passing vehicle when no vehicle appears after last one on that approach.

[Q8.](#) Because of the problem of occupancy(), we use incomplete gap() to do the job of detecting the presence. Is it all right?

[Q9.](#) One problem I should point out is that Paramics can't detect the presence of vehicles sometimes when the vehicle is over the detector. Because we have three detectors to simulate the long loop (and several lanes for a movement), this shortcoming is not serious for us. But for ramp, there is only one loop. If the detector failed to detect the presence of a vehicle, no green will be given to the ramp signal (of course we have solved the problem using our tricks). I have thought this is an unavoidable problem of simulation software because it works based on sampling at time step. This is my understanding. I don't know if it's correct. Or if Paramics can solve the problem totally, that'll be great.

[Q10.](#) During our development on full actuated signal control API, we found that Paramics didn't provide an API function for user to control the amber time (yellow light). Although yellow time can be set in the configuration file, it is universal for all the intersections and all the time. It is not convenient in the actuated signal case since some phases may be skipped (the amber time has to be skipped at the same time). In order to simulate the real world better, our developed APIs have to have a handle on the control of the amber time associated with each phase. Currently, there is no action_type in the signal_action() related to the control of yellow time. We strongly suggest that Paramics can provide this function, this will improve the simulation quality on actuated signal control greatly.

[Q11.](#) Another question is related to the parallel processing with Paramics. Since our networks become larger and larger, this feature is very important to us. Is this feature available in the current version of Paramics? Can you give me some information on this?

[Q12.](#) I think that two neighboring links have some overlapping areas in Paramics. I get this conclusion from tracing a vehicle and adding two detectors on the both sides of neighboring links. Is my idea right?

[Q13.](#) I'd like to know if Paramics use different models for freeway/highway and surface streets because Corsim uses different ones in order to simulate the different

traffic well. If so, is it possible for a vehicle to change its pointer if it travel from the surface street to the freeway?

Answer 1:

I understand the problem here; we have been looking at the development of NEMA 170 logic and have a plug-in that emulates the logic. It does need some work however to finish it off. I would be interested in hearing more about your work at UCI and your background.

My suggestion is to implement several smaller loop (about 6.6 ft or 2.0 m) and to use combine the occupied condition, for example:

```
If ((occupied [1]) or (occupied [2]) or (occupied [3])) { .... }
```

[RETRUN TO THE TOP](#)

Answer 2:

The problem is with the green1 time you had set. The program will run through the VA code every timestep (which can be every 1/2 second). The green1 time is the time left to run (the value of 0 will mean the next timestep as it cannot chane as it is being explored) if the 'if' statement is true in the next timestep also then it will again attempt to implement the change in the next timestep. Thus it was running to max.

To avoid this happening a switch can be used. Set a parameter = 0 and activate a switch when the initial conditions are met

```
if (parameter [1] = 0) { if ((green1 = 7 ) and (occupied [1] = 0)) { ## Changes i.e. green1 = 0.5 parameter [1] = 1; }
```

Remember to reset the switch to 0 once the changes to the phasing have been completed. This could be achieved using code such as this:

```
else if (occupied [1] = 1) { parameter [1] = 0; }
```

[RETRUN TO THE TOP](#)

Answer 3:

The output is designed to produce and update the normal working Paramics files; this is so the user can edit them if required. When developing plug-ins we attempt to make them as transparent as possible so that users can understand them and make manual edits without having to recompile a plug-in.

We are interested in your development of the NEMA 170 controller and would be eager to hear your thoughts on the plug-in and it's future development.

[RETRUN TO THE TOP](#)

Answer 4:

The VA Signals pseudo code uses the occupied as occupancy of greater than 0. Therefore this would be the way to replicate the occupied function in the API.

[RETRUN TO THE TOP](#)

Answer 5:

Prior to porting Paramics to the Windows OS we did produce a Linux version (approx. 2 years ago). Unfortunately the Linux platform did not prove a good host to the Paramics software as it was particularly slow and very unstable. The Linux port was discontinued soon after due to lack of demand from users. If demand from yours was sufficient high we would consider revisiting this option.

[RETRUN TO THE TOP](#)

Answer 6:

The problem that you are facing is detailed in the FAQ section of the Customer Area. This is the way that the license protection system works, once the date has been stamped on the HASP key then it will not initialise a licensed copy of Paramics prior to that date. Therefore you have two options:

- i) Wait until the 19/10/00 when the timestamp will allow Paramics to be initialised.
- ii) Use one of the other HASP keys possessed by UCI that has not been used on your PC.

[RETRUN TO THE TOP](#)

Answer 7:

Thank you for your email regarding the Occupancy [N] running values returned by the loop detectors.

Our apologies for the delay in replying to your query, however it did require a great deal of consideration. Thanks to your help in outlining your problems we have discovered a bug in the program that was not in previous versions of the software. The bug occurred due to conflict with other processes designed to ensure backward portability with earlier version of Paramics modeller.

The bug has now been fixed and occupancy (incomplete) will now display the correct values in the forthcoming build of the software.

Following QA procedures these changes will be included in the forthcoming Version 3 build 6 release scheduled for 31st October 2000. However should you have an immediate and pressing need for access to Parmaics modeller with this bug fixed please let us know as we may be able to generate an intermediate version of the software for your use only.

[RETRUN TO THE TOP](#)

Answer 8:

This is a workaround, however occupancy () incomplete is the correct way to model presence.

[RETRUN TO THE TOP](#)

Answer 9:

Because Paramics is set to emulate real detector data there is always a problem when looking at real data emulation and gathering 'perfect' data. In reality if a vehicle has not exited a loop when another vehicle has entered the loop then the presence will continue to run and the count () will not increase. This is due to the rising and falling edges of the loop detector.

To prevent this from occurring shorten the length of the loop slightly and this will make it more difficult for two vehicles to occupy the same loop.

Also if vehicles are travelling fast and pass over a loop completely in a single timestep then it will not be detected. This is, as you rightly point out, due to the discrete timestep nature of the simulation. If you wish to either increase the length of the loop slightly or increase the number of timesteps per second then this should remove this problem.

[RETRUN TO THE TOP](#)

Answer 10:

I agree that this would be a beneficial feature to add. I'll add this to the development list for Version 3.1 due out next year.

[RETRUN TO THE TOP](#)

Answer 11:

V3.0 of Paramics Parallel is not commercially available at present as we feel it requires further work to ensure stability and compatability with Paramics Modeller for commercial/academic use. As the demand for the parallel processing version of Paramics is not as great as that for other features, and with the finite resources we have available to us, we have to concentrate on those feature requested by the majority of users.

I has been the case that we have accelerated development of certain features of the past, aided by outside funding form third parties i.e. the European Commission and UCI-Irvine. Realistically, due to the limited demand and specialist nature of Paramics Parallel, we would require this sort of input from third parties to accelerate the development of this feature.

[RETRUN TO THE TOP](#)

Answer 12:

This is a fairly complex topic to describe so I will do my best to explain it fully. You are almost correct when you say that links overlap, although to be specific it's more that the "influence" or "scope" of one or more links, rather than the physical link structure, can overlap into and through nodes or junctions.

As Paramics is a link based model, vehicles cannot easily have any real physical presence on node or junction in the network as, by their definition, nodes are only a point in the network where one of more links meet. This problem is complicated because nodes/junctions cannot be realistically represented by a simple point that joins one or more links due to the detailed information needed to replicate a real world road geometry.

You can see this when you edit link kerb points i.e. the link kerb points/stoplines do not correspond to the exact location of the node the link is connected to. This is correct as any other approach would greatly oversimplify the physical representation of the network.

So the problem remains of how to "track" vehicles in the network as they move through nodes and between links. To do this Paramics continually scans the approaches of each node/junction in the network looking for vehicles that will need to be transferred from link A, through the node to link B. When a candidate vehicle if encountered (i.e. a vehicle that can be transferred without effecting other traffic or the integrity of the simulation) Paramics will transfer the vehicle.

The transfer process involves removing the vehicle from the "scope" of link A passing it through the node/junction and reassigning it to the "scope" of link B. In some case

this transfer process can take place before the vehicle has reached the end of link A i.e. if the vehicle is very close to the junction and has priority etc. In this way the transfer process can be pre-emptive for very congested networks. When this happens the vehicle will be moved to the "scope" of link B but, in the simulation, will still be treated as if it is physically located on link A and still has to pass through the junction. The visualisation is not adversely effected, nor is the interaction and cause/effect the vehicle has on any other the vehicle on the two link A and B. The 'distance' attribute of the vehicle however will be effected as even though the vehicle_link() call will return link B the real position of the vehicle is still X meters from the end of link A. This is why you see the strange changes in vehicle distance in your plugin (distance > link length), i.e. because the vehicle is in the process of being transferred between links and across a node.

You could try using the API overload functions below rather than the approach you use at present as these are better integrated into the transfer process and should give more tangible results.

```
- void vehicle_tagged_move(void *Vp, void *linkp, float distance, float speed); - void
vehicle_move(void *Vp, void *linkp, float distance, float speed); - void
vehicle_transfer(void *Vp, void *linkp, void *link2p); - void vehicle_tagged_
transfer(void *Vp, void *linkp, void *link2p)
```

[RETRUN TO THE TOP](#)

Answer 13:

The car-following and lane changing models used in Paramics do differ in some aspects depending on whether the vehicle is travelling on a highway or urban link. Vehicle pointer is the memory address that represents the top level of a vehicle structure. Obviously this is not possible. You can query the link/link type that a vehicle is currently travelling on so you can determine if the vehicle is travelling on an urban or highway link; please see the void* vehicle_link(void *Vp) function in Paramics Programmer. If this is not what you mean please expand on your query.

To trace vehicles through the network you should use the vehicle_usertag/vehicle_tracer/vehicle_tagged* functions in the Paramics Programmer User Guide and Reference Manuals.

[RETRUN TO THE TOP](#)